

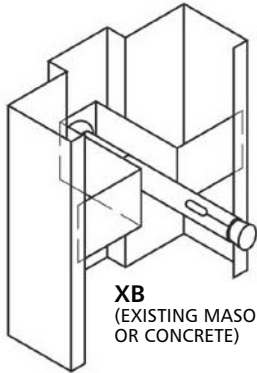

ANCHORS

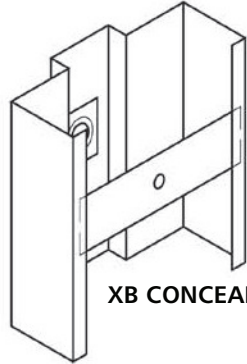

XB
(EXISTING MASONRY
OR CONCRETE)



XB CONCEALED

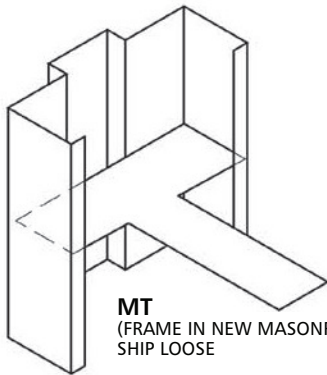
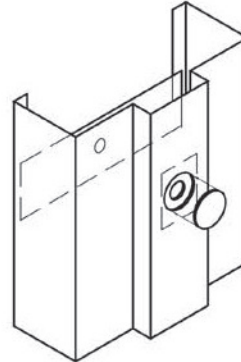

MT
(FRAME IN NEW MASONRY)
SHIP LOOSE

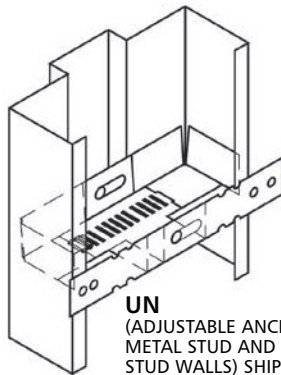

UN
(ADJUSTABLE ANCHOR FOR
METAL STUD AND WOOD
STUD WALLS) SHIP LOOSE

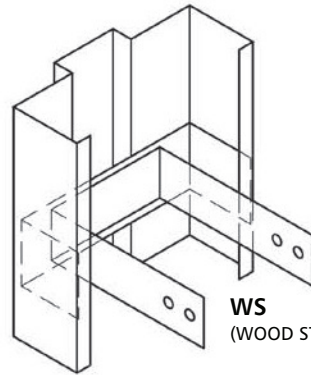

WS
(WOOD STUD WALLS)

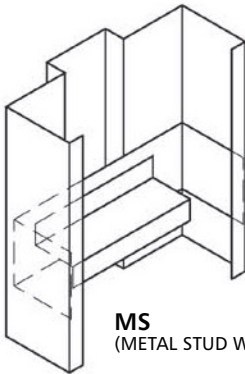

MS
(METAL STUD WALLS)

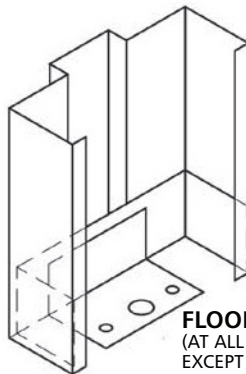

FLOOR CLIP
(AT ALL FRAMES,
EXCEPT XB ANCHOR TYPE)

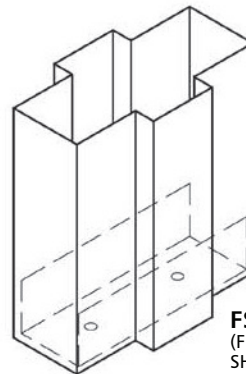

FS
(FLOOR SHOE
SHIPPED LOOSE)

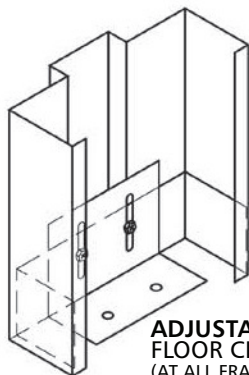

**ADJUSTABLE
FLOOR CLIP**
(AT ALL FRAMES, EXCEPT XB
ANCHOR TYPE)

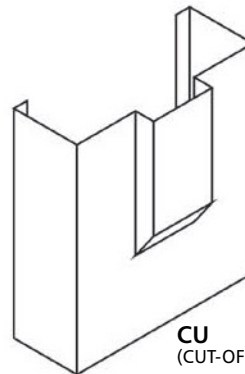

CU
(CUT-OFF STOP 45° OR 90°)